



ASCO Power Technologies™

ASCO 7000 SERIES Power Transfer Switches



ascopower.com

Life Is On 

Schneider
Electric 

ASCO 7000 SERIES POWER TRANSFER SWITCHES

Protecting:

- Healthcare Facilities
- Enterprise / Colocation / Cloud Data Centers
- Commercial Buildings / Industrial Buildings
- Telecom Mobile / Central Switching Centers
- Process Manufacturing
- Distributed Energy Resources (Microgrid) / Load Management
- Water Treatment Facilities



As society becomes increasingly dependent on the quality and reliability of electrical power, interruption or complete loss of power can result in serious hardships, significant financial losses, or dangers to life and safety.

ASCO Power Technologies (ASCO) provides industry-leading products and solutions for reliably transferring critical loads to emergency power sources. Using ASCO products can mean the difference between a minor inconvenience and a major catastrophe. You'll find ASCO Power Transfer Switches wherever there is a critical load to protect.

ASCO offers a variety of product solutions to meet virtually every requirement, including distributed generation applications. That's why the 7000 SERIES is available in open, delayed, closed and soft load transition configurations. Additionally, switched or overlapping neutral options provide for more accurate operation of ground fault protection systems and reduction of voltage transients from unbalanced load switching.



Fig. 1: Three Pole 7000 SERIES Automatic Transfer Switch rated 1600 amps (shown with optional front connected terminals and Power Meter).

7000 SERIES

ASCO Power Transfer Switches are the standard of the industry. High speed transfer of loads between alternate sources of power, regardless of ampacity, is achieved using a reliable, field-proven solenoid operating mechanism. When combined with a programmable microprocessor controller with keypad and LCD display, they offer the most advanced method of transferring all types of loads, such as motors, electronic drives, UPS's and microprocessor-based systems. 7000 SERIES Power Transfer Switches are available open or enclosed, in ampacities ranging from 30 through 4000 amps with the largest selection of optional accessories offered anywhere. All switching configurations are available with an integrally mounted bypass-isolation switch. Configurations are also available for service entrance applications.

7000 SERIES POWER TRANSFER SWITCHES PRODUCT FEATURES

- Conventional two-position transfer configuration, plus closed and delayed transition modes of operation. All configurations available with either automatic or non-automatic control.
- Listed to UL 1008 Transfer Switch Equipment for Automatic Transfer Switches and Certified to CSA 22.2, No. 178.
- Qualified and certified to IEC 60947-6-1, CE marked (optional). (Limited to certain accessories.)
- Rated up to 600 VAC, 30 through 4000 amps.
- 3 to 18-Cycle Withstand and Closing Rating (WCR) Standard, 30-Cycle WCR Optional.
- Reliable and field-proven solenoid operating mechanism.
- High WCRs including short-time withstand current rating for optimum flexibility in circuit breaker coordination (600-4000 amps).
- Solid, switched, or overlapping neutral conductor options.
- Front replaceable main and arcing contacts (800-4000 amps).
- Programmable microprocessor controller with keypad and LCD display.
- Centrally located terminal block for customer control connections (260-4000 amps).
- 16mm, industrial grade control switches and indicating lights.
- Switch position and source acceptability LED indicators.
- Standard ground conductor connections.
- Four auxiliary contacts, two contacts closed when switch is in normal position and two contacts closed when switch is in emergency position.
- Local/remote communications capability for interfacing with ASCO POWERQUEST® communication products.
- Protected by a comprehensive 2, 5, or 10 year warranty.



The Recognized Leader in Power Transfer Switch Technology Offers the Most Advanced Transfer Switches in the World.

ASCO 7000 SERIES POWER SWITCHING SOLUTIONS

Automatic & Non-Automatic Transfer Switching

ASCO Transfer Switches are available in both automatic & non-automatic initiation types. Both types are electrically operated. For automatic transfer switches, the controller initiates transfer. For non-automatic transfer switches, the user initiates switching transfer between power sources using switches mounted locally or at remote locations. Non-automatic switches have the following features:

- Sizes from 30 through 4000 amps.
- Microprocessor-based controller provides for addition of optional accessories.
- Controller prevents inadvertent operation under low voltage conditions.
- Low control circuit operating currents allow for long distances between remotely mounted manual control switches and the transfer switch.
- Source acceptability lights inform operator when sources are available to accept load.
- Standard inphase monitor can be activated for transferring motor loads.



Fig. 2: Four Pole, Non-Automatic, Electrically-Operated 400 Amp Switch in a Type 1 Enclosure.

ASCO 7000 SERIES POWER SWITCHING SOLUTIONS

Open Transition Transfer Switching

ASCO Transfer Switches are available in a standard, 2-position, open transition configuration to reliably transfer loads between power sources. Loads transfer to the alternate source in less than 100ms. In phase transfer can be activated for transferring motor loads. Open transition switches are suitable for a wide range of applications.

- Available from 30 to 4000 amps.
- Utilizes reliable, field-proven, single solenoid operating mechanisms.
- Single operator design prevents direct connection of both sources.

Delayed Transition Transfer Switching

ASCO Delayed Transition Transfer Switches are designed to provide transfer of loads between power sources with a timed load disconnect position for an adjustable period of time. Applications include older style variable frequency drives, rectifier banks, and load management applications.

- 150 through 4000 amps.
- Utilizes reliable, field-proven solenoid operating mechanisms.
- Mechanical interlocks to prevent direct connection of both sources.
- Indicator light (16mm, industrial grade type LED) for load disconnect position.
- Adjustable time delay for load disconnect position.

Closed Transition Transfer Switching

ASCO Automatic Closed Transition Transfer Switches feature main contacts that overlap, permitting the transfer of electrical loads without power interruption. The switch transfers in a make-before-break mode if both sources are within acceptable parameters. Control logic continuously monitors source conditions and automatically determines whether the load transfer should be open (conventional non-overlap mode) or closed transition.

- Available 150 through 4000 amps.
- Utilizes reliable, field proven solenoid operating mechanism.
- Closed Transition Transfer is achieved passively within 5 electrical degrees, without control of engine generator set.
- Additional control wiring not required.
- Overlap time is less than 100 milliseconds (consult your local utility on protective relay requirements).
- Failure to synchronize and extended parallel time indication.



Fig. 3: Four pole, Delayed Transition 2000 Amp Transfer Switch.



Fig. 4: Four Pole, Closed Transition, 1000 Amp Transfer Switch in a Type 1 enclosure.

WITHSTANDING AND CLOSING ON SHORT CIRCUIT FAULT CURRENTS

Withstanding and closing on short circuit currents require transfer switches that can handle extremely high electromagnetic forces and thermal stresses. Circuit breakers and fuses are designed to open on short circuit currents. However, while transfer switches must withstand a short circuit current until the over-current device clears the fault.

The withstand and closing rating (WCR) indicates the highest level of current a transfer switch can close on and carry for a specific amount of time. For system coordination purposes, the time must be sufficient for the upstream over-current protective device to clear the fault. The WCR must equal or exceed the available fault current and system voltage at the power source terminals of the switch.

The purpose of a power transfer switch is to maintain power to the load, whereas an overcurrent device is designed to open under a fault condition to protect the circuit conductors and equipment. ASCO power transfer switches use a unique solenoid operator design to force and lock the main contacts closed on a high current fault, rather than allowing them to open like a circuit breaker.

Main contact material composition, contact geometry, arcing contact design, and other features all affect the ability of the power transfer switch to withstand and close-on high fault currents. ASCO employs a variety of computer modeling programs to determine the optimal combination of all these elements to create a superior transfer switch design.

ASCO power transfer switches are available with a full range of WCRs to accommodate a variety of over-current devices with fault-clearing times from 0.004 to 0.5 seconds (1/4 to 30 cycles). In fact, ASCO transfer switches provide the industry's most comprehensive solution for all short circuit requirements. Our 7000 SERIES WCR table addresses all time-based, specific breaker, current-limiting fuse, and short-time ratings necessary for accommodating selective coordination requirements.

In order to meet NEC selective coordination requirements, short-time settings are specified on circuit breakers following a coordination study. A circuit breaker's short-time settings require transfer switches to withstand and close-on short circuit currents for time durations of 0.1 seconds (6 cycles for a 60Hz system) or longer. The 4th Edition of UL1008 added this optional "Short-Time Rating" for transfer switches in 2002. Underwriters Laboratories does not require a specific time or specific number of cycles to qualify for this rating, but the transfer switch WCRs must coordinate with the short-time settings on the breakers.

While there are no ideal time delay breaker settings for selective coordination, many engineers have been successful with using 0.3 seconds (18 cycles) for the most upstream breaker short-time settings. However, 0.5 second (30-cycle) settings may be required for larger projects with multiple levels of distribution breakers or where transfer switches are served by ANSI switchgear with 30-cycle withstand ratings.

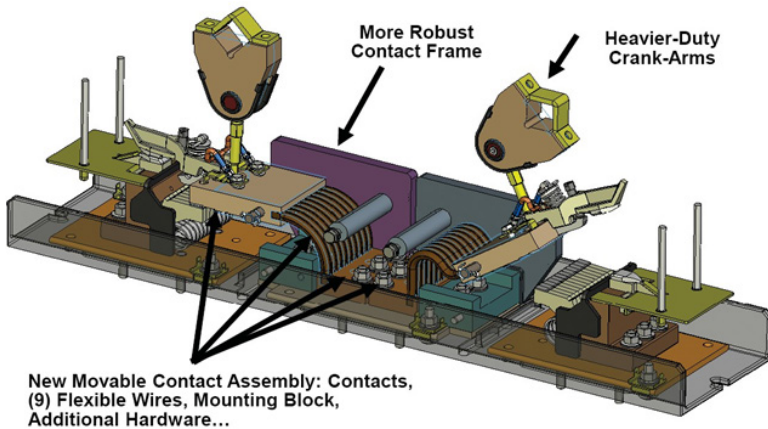

As with most electrical devices, higher ratings usually result in higher costs. The goal is to optimize selective coordination in the system while incorporating power transfer switches at a reasonable cost. ASCO 7000 SERIES H and G frame Power Transfer Switches include a 0.3 second (18-cycle) short-time rating as standard along with a 0.05 second (3-cycle) short-circuit rating. The 18-cycle rating should be sufficient to

satisfy most selective coordination requirements without adding cost to the transfer switch budget.

The ASCO P, Q, S, and U frame 7000 SERIES Power Transfer Switches are perfect for larger projects, or for systems using ANSI switchgear requiring a 0.5 second (30-cycle) rating. These switches feature a re-designed contact assembly with more robust contact frames, heavier-duty crank arms, and a high-speed coil closing circuit. These design enhancements enable flexibility for selective coordination solutions and provide safe and reliable fault current endurance for up to 0.5 seconds.

ASCO Withstand and Closing Ratings for all 7000 SERIES Products^{1,2}

(RMS Symmetrical Amps)

The chart below indicates Withstand and Closing Ratings for all 7000 SERIES Power Transfer Switches, including 0.5 second (30-cycle) designs.

Frame	Switch Rating (Amps)		Current Limiting Fuses				Specific Breaker			Time Based				Short Time Ratings ³ (sec)					
	Transfer Switches	Bypass Switches	480V Max.	600V Max.	Max Size, A	Class	240V Max.	480V Max.	600V Max.	Time (sec)	240V Max.	480V Max.	600V Max.	480V Max.			600V Max.		
														.13	.2	.3	.5	.1	.13
D	30	-	100kA	-	300	J	22kA	22kA	10kA	0.025	10kA	10kA	10kA	-			-		
			200kA	35kA	200	J								-			-		
			35kA	35kA	200	RK1								-			-		
D	70, 100	-	35kA	35kA	200	RK1	150kA	85kA	25kA	0.025	10kA	10kA	10kA	-			-		
			200kA	35kA	200	J								-			-		
D	150	-	35kA	35kA	200	RK1	150kA	85kA	25kA	0.025	10kA	10kA	10kA	-			-		
			200kA	35kA	200	J								-			-		
D	200	-	200kA	-	200	J	200kA	85kA	14kA	0.025	10kA	10kA	10kA	-			-		
D	230	-	100kA	-	300	J	200kA	85kA	14kA	0.025	10kA	10kA	-	-			-		
J	150, 200, 260	150, 200, 230, 260	200kA	200kA	600	J	200kA	200kA	42kA	0.05	65kA	42kA ⁵	35kA	7.5kA	-		-		
					800	L								-		-			
J	400	400	200kA	200kA	600	J	65kA	50kA	42kA	0.05	65kA	42kA ⁵	35kA	7.5kA	-		-		
					800	L								-		-			
J	600	600	200kA	200kA	800	L	65kA	50kA	42kA	0.05	65kA	42kA ⁵	35kA	7.5kA ⁹	-		-		
			200kA	200kA	600	J								-		-			
H ⁸	600	600	200kA	200kA	1600	L	65kA	65kA	65kA	0.05	50kA	50kA	50kA	36kA	-		36kA	-	
P ⁸	600	600	200kA	200kA	1600	L	65kA	65kA	65kA	0.05	50kA	50kA	50kA	36kA	30kA	36kA	-	-	
P ⁸	800	800 - 1200	200kA	200kA	1600	L	65kA	65kA	65kA	0.05	50kA	50kA	50kA	36kA	30kA	36kA	-	-	
H	800 - 1200	800 - 1200	200kA	200kA	1600 ⁴	L	65kA	65kA	65kA	0.05	50kA	50kA	50kA	36kA	-		36kA	-	
Q ⁸	600-1600	600-1600	200kA	200kA	2000	L	65kA	65kA	65kA	0.05	65kA	65kA	65kA	50kA			50kA		
S ⁸	800 - 1200	800 - 1200	200kA	200kA	2500	L	100kA	100kA	65kA	0.05	100kA	100kA	65kA	65kA			65kA		
G ⁸	1000 - 1200	1000 - 1200	200kA	200kA	2000	L	85kA	85kA	85kA	0.05	85kA	85kA	85kA	-			-		
G	1600 - 2000 (Front Connected TS Only)		200kA	200kA	2500	L	85kA	85kA	85kA	0.05	85kA	85kA	85kA	42kA	36kA		-		
G ⁸	1600 - 2000	1600 - 2000	200kA	200kA	3000	L	125kA ⁶	125kA ⁶	100kA	0.05	100kA	100kA	100kA	42kA	36kA	42kA	-	-	
S ⁸	1600 - 2000	1600 - 2000	200kA	200kA	2500	L	100kA	100kA	85kA	0.05	100kA	100kA	85kA	85kA	65kA	85kA	65kA	-	-
G	2600 - 3000	2600 - 3000	200kA	200kA	4000	L	100kA	100kA	100kA	0.05	100kA	100kA	100kA	42kA	36kA	42kA	-	-	
G ⁸	3200	-	200kA	-	4000	L	100kA	100kA	-	0.05	100kA	100kA	-	-			-		
G	4000	4000	200kA	200kA	5000	L	100kA	100kA	100kA	0.05	100kA	100kA	100kA	85kA	65kA		65kA		
U ⁸	2600 - 4000	2600 - 4000	200kA	200kA	5000	L	125kA	125kA	125kA	0.05	125kA	125kA	125kA	100kA			100kA		

Notes:

1. All WCR values indicated are tested in accordance with the requirements of UL 1008, 7th Edition. See ASCO Pub. 1128 for more WCR information.
2. Application requirements may permit higher WCR for certain switch sizes.
3. Short Time ratings are provided for applications involving circuit breakers that utilize trip delay settings for system selective coordination.
4. Max fuse rating is 1200A on front connected H frame switches.
5. Switches utilizing overlapping neutral (code "C") have 35kA, 0.050 Sec time based rating at 480V Max.
6. Rating shown is for Bypass switches only, Transfer Switch rating is 100kA.
7. Contact ASCO for Service Entrance Switch ratings.
8. Short Time Rating applies to 600A Bypass switch only, the 600A Transfer Switch does not have a Short Time Rating.

ASCO 7000 SERIES BYPASS ISOLATION SWITCHES

Automatic Transfer Bypass-Isolation Switches

ASCO Automatic Transfer & Bypass-Isolation Switches are available in open transition, closed transition, and delayed transition designs. The bypass and isolation features allow the primary automatic transfer switch to be inspected, tested, and maintained without interrupting power to the load. They also provide redundant power transfer if the ATS is disabled or removed from service.

- Available 150 to 4000 amps.
- Allows bypass-isolation without load interruption.
- Bypass switch and transfer switch have identical electrical ratings.
- Heavy-duty mechanical interlocks prevent unintended operation.
- Bypass contacts carry current only during bypass mode.
- Drawout design allows for easy transfer switch maintenance.
- Bypass and isolation handles are permanently mounted. The bypass switch has dead front quick-make, quick-break operation for transferring loads between live sources.
- Bypass switch is fully rated for use as a manual 3-position transfer switch.
- Bypass and isolation functions are simple, requiring a total of two operating handles.
- No toggle switches, push buttons, selector switches, or levers are required for bypass-isolation operation.
- Mechanical indicators show bypass and transfer switch positions.
- 800 - 1200 amp models available in shallow depth, front connected or rear connected designs.



Fig. 5: J-Frame
150-600 amps



Fig. 6: H-Frame
600-1200 amps



Fig. 7: G-Frame
1000-3000 amps



Fig. 8: G-Frame
4000 amps

Transfer Switch Drawout Features (150-4000 Amps)

- Automatic secondary disconnects remove all control power as switch is withdrawn.
- Drawout carriage provides for easy transfer switch mechanism maintenance and/or removal via commercially available breaker hoists.
- Optional transfer switch lifting yoke kit available
- Optional automatic shutters that close when the transfer switch is withdrawn to provide bus isolation. Specify accessory 82C (1600-3000 Amp only).

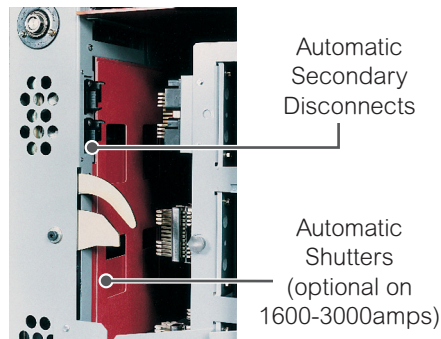

Fig. 9: Bypass-Isolation Transfer Switch Secondary Disconnects and Optional Automatic Shutters.

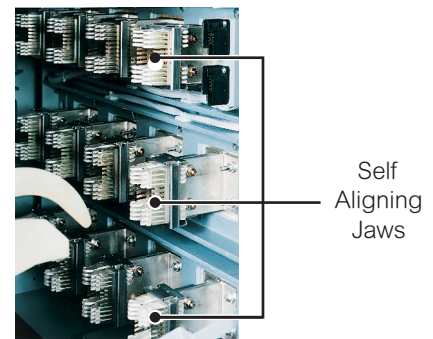
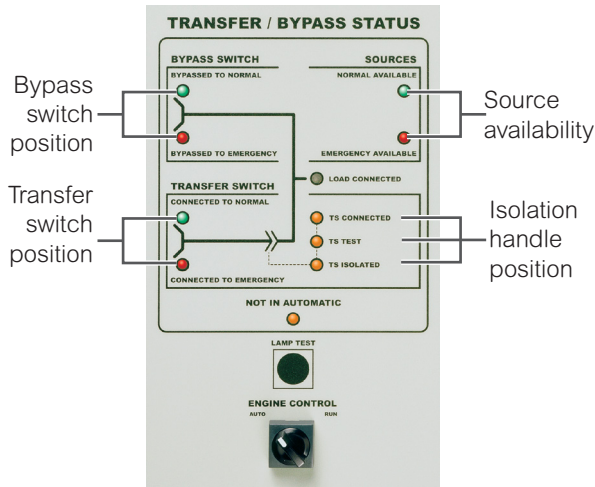

Fig. 10: Bypass-Isolation Transfer Switch Self-Aligning Power Jaws.

ASCO 7000 SERIES BYPASS ISOLATION SWITCHES

Bypass and Isolation Handles - Simple as 1, 2, 3



1 Bypass to Normal

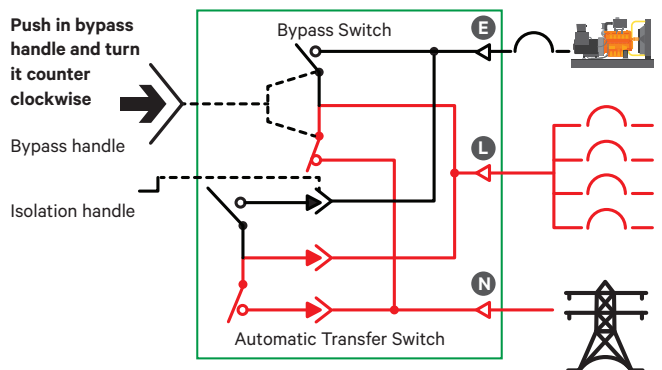

2 Test Position

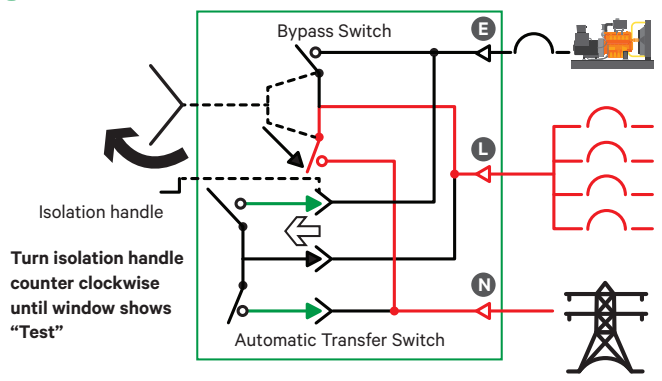

3 Isolation Position

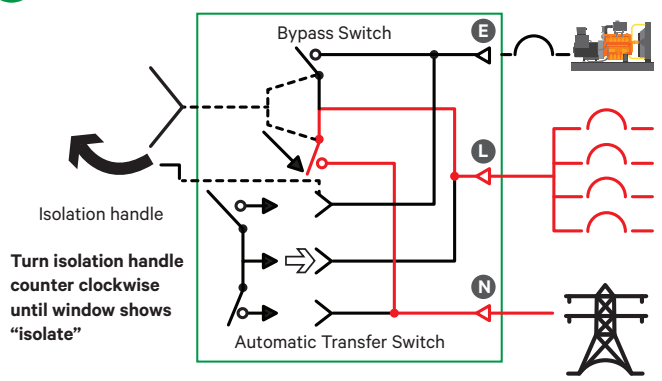

Mechanical isolation handle position window (connected/test/isolate)

ASCO 7000 SERIES SERVICE ENTRANCE POWER TRANSFER SWITCHES

The ASCO Service Entrance Power Transfer Switch combines automatic power switching with a disconnect and overcurrent protective device on the utility source. The power transfer switch meets all National Electric Code requirements for installation at a facility's main utility service entrance. Service entrance rated transfer switches generally are installed at facilities that have a single utility feed and a single emergency power source. A circuit breaker serves as the utility disconnect and links are provided to disconnect both neutral and ground connections. This product is available up to 600V and 4000 amps in Standard, Delayed, Closed Transition, Soft Load, and Bypass Isolation Configurations.

Standard Features

- Available from 70 to 4000 amps
 - 70 - 400 amp listed to UL 1008
 - 600 - 4000 amp listed to UL 891
- The ASCO 7000 SERIES Power Transfer Switch mechanism is UL 1008 Listed
- Standard UL Type 1 Enclosure
- Disconnect and overcurrent protective device on the utility source. 70 to 2000 amp models use molded case circuit breakers; 2500 to 4000 amp models use insulated case circuit breakers.
- Disconnect link on Neutral
- Disconnect link on Ground
- Ground and Neutral Bus, all silver-plated copper
- Solderless screw-type terminals for External Power Connections
- Meets all NEC requirements for use as service entrance
- Internet-enabled monitoring and control
- Service Entrance Continuous Breaker Ratings: 80% for standard transfer switches below 2500 amps and Bypass Isolation Switches below 1000 amps, otherwise 100%

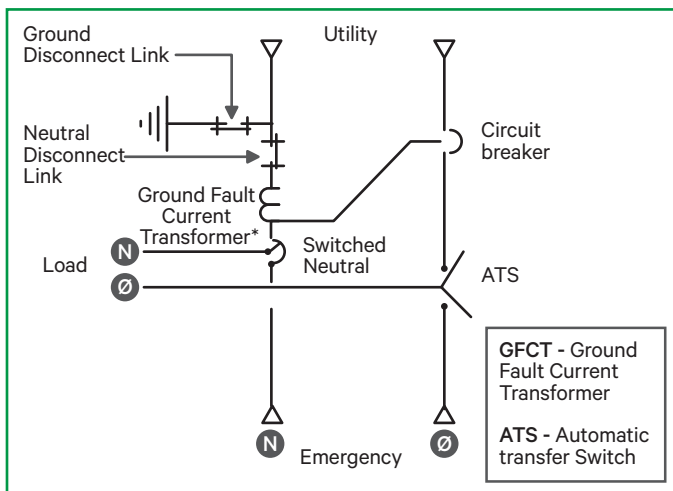

One line diagram of a typical service entrance-rated transfer switch available in Solid, Switched or Overlapping Neutral

*Ground fault trip protection provided on models of 1000 amps and above



Fig. 13: Ground and neutral disconnect links



Additional Options

- Enclosures - Secure Door Over Door/Panel
 - UL Type 3R w/strip heater & thermostat
 - UL Type 4 or 4X
 - UL Type 12
- Connections
 - Crimp lugs
 - Bus Riser on Normal, Emergency or Load
- Protective Relays/Metering
 - Accessory 135L (see page 22)
- Surge Suppression
 - Accessory 73, Surge protector (see page 19)
- Additional Breaker(s)
 - Circuit Breaker on Emergency
 - Load Distribution Panel
- Optional High AIC Ratings on Breakers
- Technology Packages including
 - 7-inch Color Touch Display including 5210 Meter (Acc. 150AT/150BT)
 - 7-inch Color Touch Display Interface including 5410 Power Quality Meter (Acc. 150AT1/150BT1)
 - Base Package including 5210 Power Meter (Acc. 150A/150B)
- ATS Remote Annunciators (see page 23)
 - 1-ATS 7-inch Color Touch Annunciator (5370)
 - 8-ATS / 1-ATS LED Annunciator (5350/5310)
- Remote Power Monitoring (see pages 25-27)
 - 8-Device Annunciator, (5705)
 - Critical Power Management System (5710/5750/5790)

Note: All Tech Packs include Meter, Acc. 72EE2 Ethernet Module and Acc.1PS1 power ride-through. 150A* (ATS) and 150B* (Bypass ATS).

Consult ASCO for additional features

ASCO 7000 SERIES GROUP 5 CONTROLLER

The 7000 SERIES Controller (Group 5) is used with all sizes of Power Transfer Switches from 30 through 4000 amps. It is the most reliable and field-proven transfer switch controller in the industry and includes, as standard, all of the voltage, frequency, control, timing and diagnostic functions required for most emergency and standby power applications. It can be equipped with a color Touch Display Interface that provides information to better manage your transfer and bypass switch. (See page 16 for additional information)

Because severe voltage transients are frequently encountered in industrial distribution systems, the controller's logic board is separated and isolated from its power board. This improves electrical noise immunity performance and helps assure compliance with the rigorous transient suppression standards shown in the table below.

Group 5 Controller
Standard Display

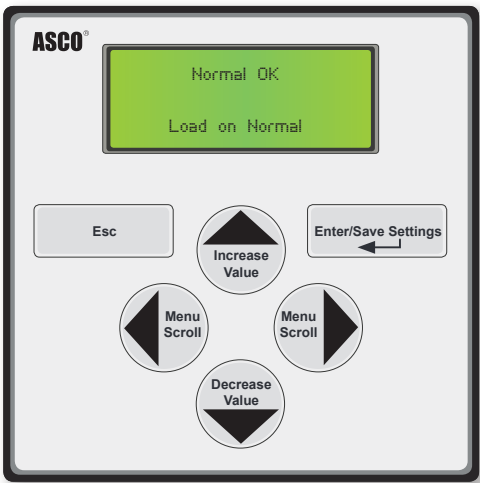

Advanced Touch Display Interface (TDI)
Accessory 150 Tech. Package (see page 16)

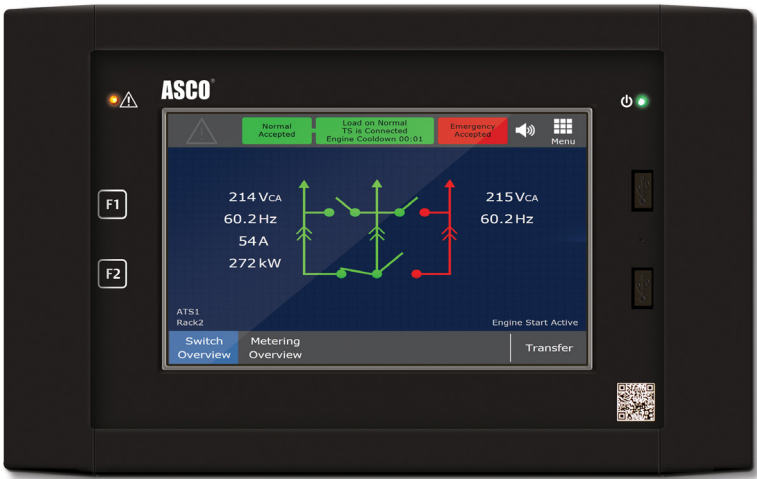

7000 SERIES Group 5 Controller

Emission Standard - Group 1, Class A	EN 55011:1991
Generic Immunity Standard, from which:	EN 50082-2:1995
Electrostatic Discharge (ESD) Immunity	EN 61000-4-2:1995
Radiated Electromagnetic Field Immunity	ENV 50140:1993
Electrical Fast Transient (EFT) Immunity	EN 61000-4-4:1995
Surge Transient Immunity	EN 61000-4-5:1995
Conducted Radio-Frequency Field Immunity	EN 61000-4-6:1996
Voltage Dips, Interruptions and Variations Immunity	EN 61000-4-11:1994

ASCO 7000 SERIES GROUP 5 CONTROLLER

Control Features

- Touch pad programming of features and settings without the need for meters or variable power supplies.
- Sixteen (16) selectable operating voltages available in a single Controller.
- On-board diagnostics provide control panel and ATS status information for analyzing system performance.
- Displays and counts down active timing functions.
- Selectable multi-language display (English, German, Portuguese, Spanish, or French. For other languages, contact ASCO).
- Password protection to prevent unauthorized tampering of settings.
- Optional Color Touch Display Interface simplifies control management and expands event log to 1,000 events. Specify Accessory 150AT (ATS) or 150BT (Bypass).
- Remote monitoring and control with ASCO POWERQUEST® communication products. Specify Accessory 72EE2.
- Load shed option for bus optimization applications. Specify optional accessory 30B.
- Historical event log.
- Statistical ATS systems monitoring information.

Voltage and Frequency Sensing

- 3-Phase under-voltage and over-voltage settings on normal and emergency sources.
- Under-frequency and over-frequency settings on normal and emergency.
- True RMS Voltage Sensing with +/- 1% accuracy; Frequency Sensing Accuracy is +/- 0.2%.
- Selectable settings: single or 3-phase voltage sensing on normal and emergency; 50 or 60Hz.
- Phase sequence sensing for phase-sensitive loads.
- Voltage unbalance detection between phases.

Status and Control Functions

- Output contact (N/O or N/C) for engine-start signals.
- Selection between “commit/no-commit” on transfer to emergency after engine start and normal restores before transfer.
- Advanced inphase algorithm that automatically measures the frequency difference between the two sources and initiates transfer at appropriate phase angles to minimize disturbances when transferring motor loads.
- Standard event log displays 99 logged events with the time and date of the event, event type and event reason.
- Output signals for remote indication of normal and emergency source acceptability
- Statistical ATS/System monitoring data screens that provide:
 - Total number of ATS transfers.
 - Number of ATS transfers caused by power source failure.
 - Total number of days ATS has been in operation.
 - Total number of hours that the normal and emergency sources have been available.

Time Delays

- Engine start time delay - delays engine starting signal to override momentary normal source outages - adjustable 0 to 6 seconds.
- Transfer to emergency time delay - adjustable 0 to 60 minutes.
- Emergency source stabilization time delay to ignore momentary transients during initial generator set loading - adjustable 0 to 6 seconds.
- Retransfer to normal time delay with two settings:
 - Power failure mode - 0 to 60 minutes.
 - Test mode - 0 to 10 hours.
- Unloaded running time delay for engine cool down - adjustable 0 to 60 minutes.
- Pre-transfer and post-transfer signal time delay for selective load disconnect with a programmable bypass on source failures - adjustable 0 to 5 minutes. This signal can be used to drive a customer-furnished relay, or for two sets of double throw contacts rated 3 amps at 480 volts AC. Specify ASCO optional accessory 31Z.
- Fully programmable engine exerciser with seven independent routines to exercise the engine generator, with or without loads, on a daily, weekly, bi-weekly or monthly frequency.
- Alarm signals, logic, and time delays for use with closed transition switches.
 - In synch time delay - 0 to 3 seconds.
 - Failure to synchronize - 1 to 5 minutes.
 - Extended parallel - 0.1 to 1.0 seconds.
- Delayed transition load disconnect time delay - adjustable 0 to 5 minutes.

ASCO 7000 SERIES POWER CONTROL CENTER

Status

System Status

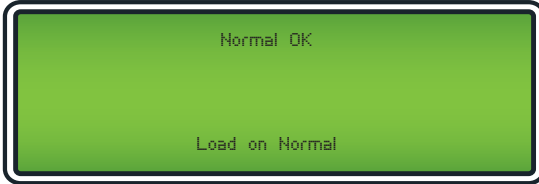

Displays system status in clear, concise language. Message shown indicates normal source is acceptable and the load is connected to the normal source.

Source Status

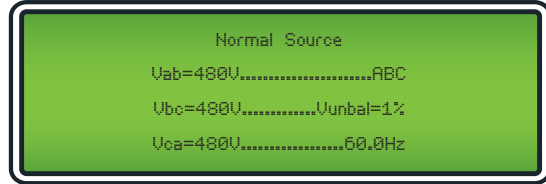

Displays voltage for each phase, frequency, phase rotation and voltage unbalance for both normal and emergency sources.

Time Delay Status

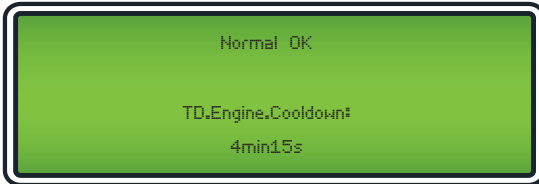

Active time delay status displays time remaining until next control event.

Inphase Transfer Status

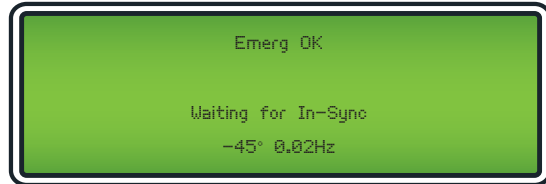

Displays the relative phase angle between sources and frequency differential to indicate the controller is awaiting an inphase condition.

Settings

Voltage and Frequency Settings

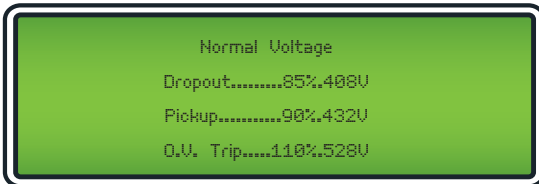

Provides voltage and frequency setting values for normal and emergency sources. Voltage pick-up, dropout and trip settings are set in percentage of nominal voltage and are also displayed in rms voltage values.

Feature Settings

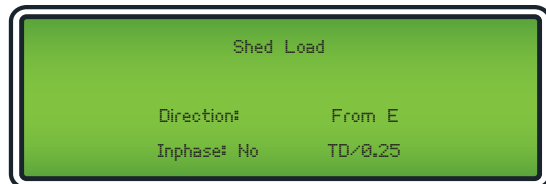

Standard features can be activated with the keypad. As an example, when enabled, the "shed load" option causes the transfer switch to transfer the load off of the specified source. If desired, the load shed transfer can be made inphase.

Engine Exerciser

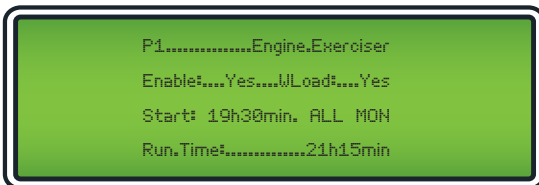

Seven independent programs, load/no load selection, flexible run times and daily, weekly, bi-weekly and monthly exercise routines.

Time Delay Settings



Provides direct reading display for setting time delays.

Data Logging

ATS Statistics

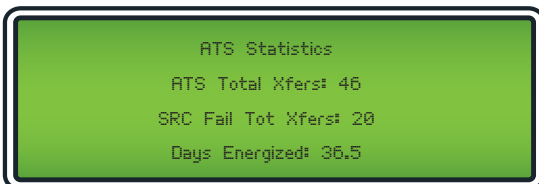

Instant availability of statistical information on total number of ATS transfers, number of transfers caused by power failures and total days controller has been energized, plus more.

Historical Event Log

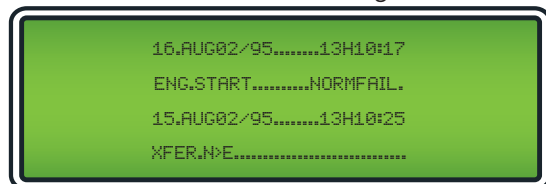

Displays detailed information for last 99 events, including time of occurrence, length of event, date and reason for event.

ASCO 7000 SERIES USER CONTROLS AND INDICATORS

Control Switches and Indicating Lights

- Switch position indicating lights (16 mm, industrial grade LEDs).
- Source acceptability indicating lights with true indication of the acceptability of each source, as determined by the voltage, frequency, voltage unbalance, and phase sequence settings of the control panel (16mm, industrial grade LEDs).
- Three position (16mm, industrial grade type) selector switch:
 - Automatic: Normal maintained position.
 - Test: Momentary position to simulate normal source failure for system test function.
 - Reset Delay Bypass: Momentary position to bypass transfer and re-transfer time delay.

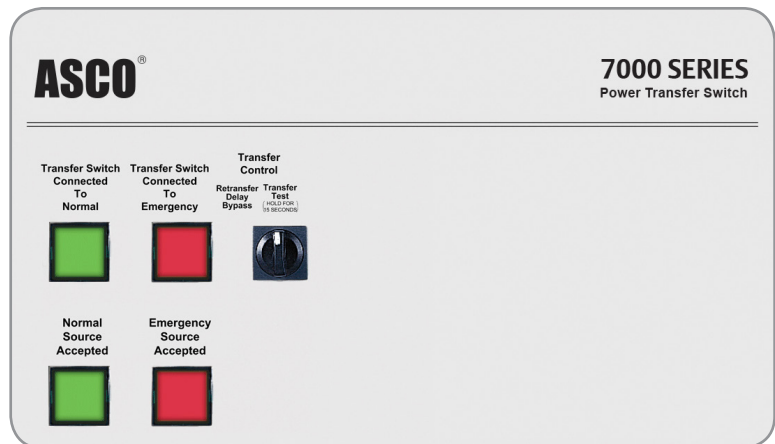

Fig. 16: 7000 SERIES User Controls and Indicators.

Control Switches and Indicating Lights for Closed Transition Switches

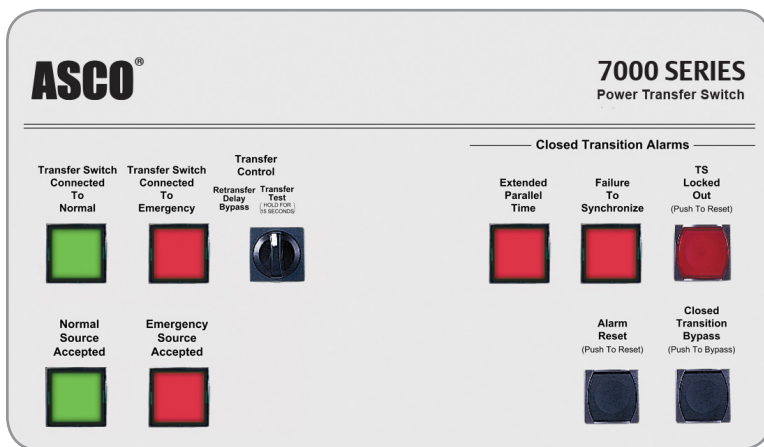

Fig. 17: 7000 SERIES User Controls and Indicators.

- Extended Parallel Time - Provides visual indication when the pre-set extended parallel time has been exceeded. The controls automatically open the emergency or normal main contacts. Separate contact also available to shunt trip external breaker.
- Failure To Synchronize - Visually displays a failure to synchronize alarm if the time delay settings are exceeded during closed transition transfer operation.
- TS Locked Out - Prevents transfer in either direction if the extended parallel time is exceeded.
- Alarm Reset - Resets extended parallel and failure to synchronize alarms.
- Closed Transition Bypass - Pushbutton allows transfer between sources in an open transition mode.

ASCO 7000 SERIES OPTIONAL ACCESSORIES

Time Delays and Extended Control Power

- 2C** Provides an extended time delay on engine starting. The standard feature one-time delay is adjustable from 0 to 6 seconds. Accessory 2C allows this time delay to be adjustable from 0 to 60 minutes in one-second intervals; factory set at 5 minutes.
- 1G1** Similar to accessory 2C except using 24 volt DC external input signal. Controls, metering and communication remain active when both power sources are de-energized.
- 1GB1** Same as accessory 1G1 except using 120 volt AC external input.
- 1PS1** Extended control power ride-through (approx. 25 seconds) for Group 5 ATS controller and select communications and metering accessories, e.g. Acc. 72EE2, 72FC, 135L, etc.

Manual Controls for Automatic Transfer Switches

- 6C** Reset switch for manual retransfer to normal with automatic retransfer in the event of emergency source failure.
- 6D** Selector switch for automatic/manual retransfer to normal. Automatic bypass if emergency fails.

Extension Harness

37B Six foot (6') extension harness to increase distance between transfer switch and control panel on open-type units.

Indicators

14A/14B Additional auxiliary contact sets to indicate switch position. Two sets are standard. Specify total number of sets if more are required.

18B Two-pole, double-throw contacts operate when emergency source voltage is present at transfer switch terminals.

18G Two-pole, double-throw contacts operate when normal source voltage is present at transfer switch terminals.

99 "Push-to-Test" feature on all pilot light indicators.

Customer Control Circuits

30A Load-shedding circuit initiated by opening of a customer-supplied contact.

30B* Load-shedding circuit initiated by removal of customer-supplied control voltage. *(Specify voltage).

31Z Selective load disconnect control contacts (two provided) that operate with time delay prior to and/or after load transfer and retransfer.

43R Terminal block for all customer control connections on 30 to 150 amp models only (standard on all other sizes).

Neutral Conductor Options

- Solid neutral, with fully-rated terminals. (AL-CU) UL Listed.
- Conventional neutral switching pole.
- Overlapping neutral transfer contacts. Allows for proper ground-fault sensing and avoids generator voltage transients during transfer.

Note: For ordering information, see the ASCO 7000 Series Power Transfer Switch Dimensional Data and Shipping Weights (ASCO Publication No. 3040 DW)

Communications

107G Provides Building Monitoring Systems with transfer switch, bypass and load power metering information in Modbus TCP/IP, BACnet IP and SNMP Protocols. Compatible with any Accessory 150 Technology Package or 72EE2.

72EE2 Offers remote Ethernet monitoring via open Mod bus and SNMP protocols, email notifications and embedded monitoring web pages. (Catalog No. 5170 for stand alone product).

Surge Protection

ASCO 510 TVSS, rated 65KA

73AC1 Normal source protection. (3Ø, 4wire WYE)

73AC2 Emergency source protection. (3Ø, 4wire WYE)

73AC3 Load side protection. (3Ø, 4wire WYE)

Note: Other distribution voltages and kA ratings available (Contact ASCO).

Special Applications

45 Custom Alphanumeric nameplate mounted on the front of the switch

111A Generator - to - Generator for Standby Applications

111B Generator - to - Generator for Prime Power Applications

125A Seismic Certification to the requirements of the International Building Code for electrical equipment

131 Certification of compliance with the American Recovery & Reinvestment Act (Buy American Provision) - Must be specified at time of order placement

Bypass-Isolation switch Options

14A1 Auxiliary contact to close in "Bypass to Normal" position.

14B1 Auxiliary contact to close in "Bypass to Emergency" position.

14T Auxiliary contact to close when transfer switch is in "Automatic" position.

14U Auxiliary contact to close when transfer switch is in "Isolate" position.

14V Auxiliary contact to close when transfer switch is in "Test" position.

82C Automatic shutters for bus isolation when transfer switch is withdrawn. (See page 6 for details)

82E LED Bypass status indicator, optional on G frame 1600 to 4000 amps only. Standard for all other size switches.

ASCO TOUCH DISPLAY INTERFACE TECHNOLOGY PACKAGE

The Touch Display Interface (TDI) is the best way to comprehensively connect to and manage your power transfer switch. The TDI enables you to centrally monitor, control and log the performance of transfer and bypass switches and power meters from a single device. It provides you with quick access to real-time information and historical event logs needed to increase the reliability, efficiency, and regulatory compliance of your power system.



Accessory 150BT Technology Package on a 7000 SERIES Bypass Transfer Switch.

Local Graphical Color Touch Interface

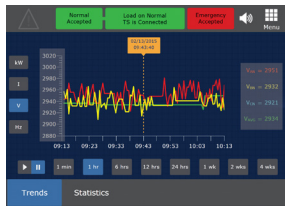
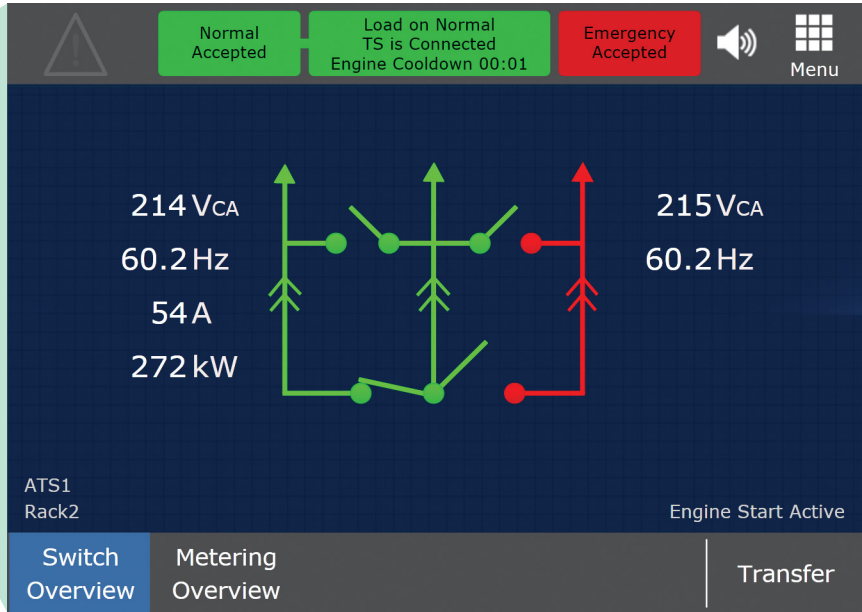

4-Week Historical Trending

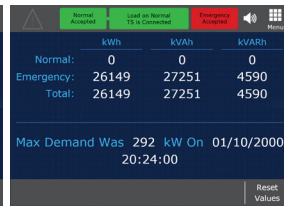

Power & Energy Usage

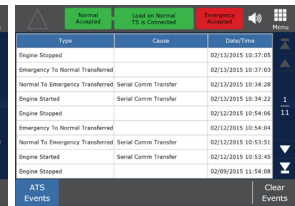

Events Log (1,000 Events)

Technology Packages are the easiest way to locally and remotely manage your critical power transfer switch and bypass switch.

Technology Package Options¹

Included Meter	Standard Tech Package		Tech Package with Touch Display Interface	
	For ATS	For ATB	For ATS	For ATB
5210 Power Meter	150A	150B	150AT	150BT
5410 Power Quality Meter	150A1	150B1	150AT1 ²	150BT1 ²
5450 Power Quality Meter	150A2	150B2	150AT2 ²	150BT2 ²
5490 Power Quality Meter	150A3	150B3	150AT3 ²	150BT3 ²

Notes

- All Technology Packages includes Acc. 1PS1, 72EE2, Meter of choice, CTs, Shorting Blocks and Bypass Status Monitoring via discrete I/O when necessary.
- Contact for availability.

ASCO MONITORING GATEWAY ACCESSORIES

The Monitoring Gateway (Accessory 107G) monitors the state and performance of your transfer switch and its associated devices, including engine-generators, utility power quality meters, surge protection devices, and circuit breakers. The Monitoring Gateway simplifies the NFPA 110 fire code and Joint Commission compliance and reporting activities required for critical and healthcare facilities. It is compatible with Building Monitoring Systems, sharing data in open Modbus TCP/IP and BACnet IP formats.

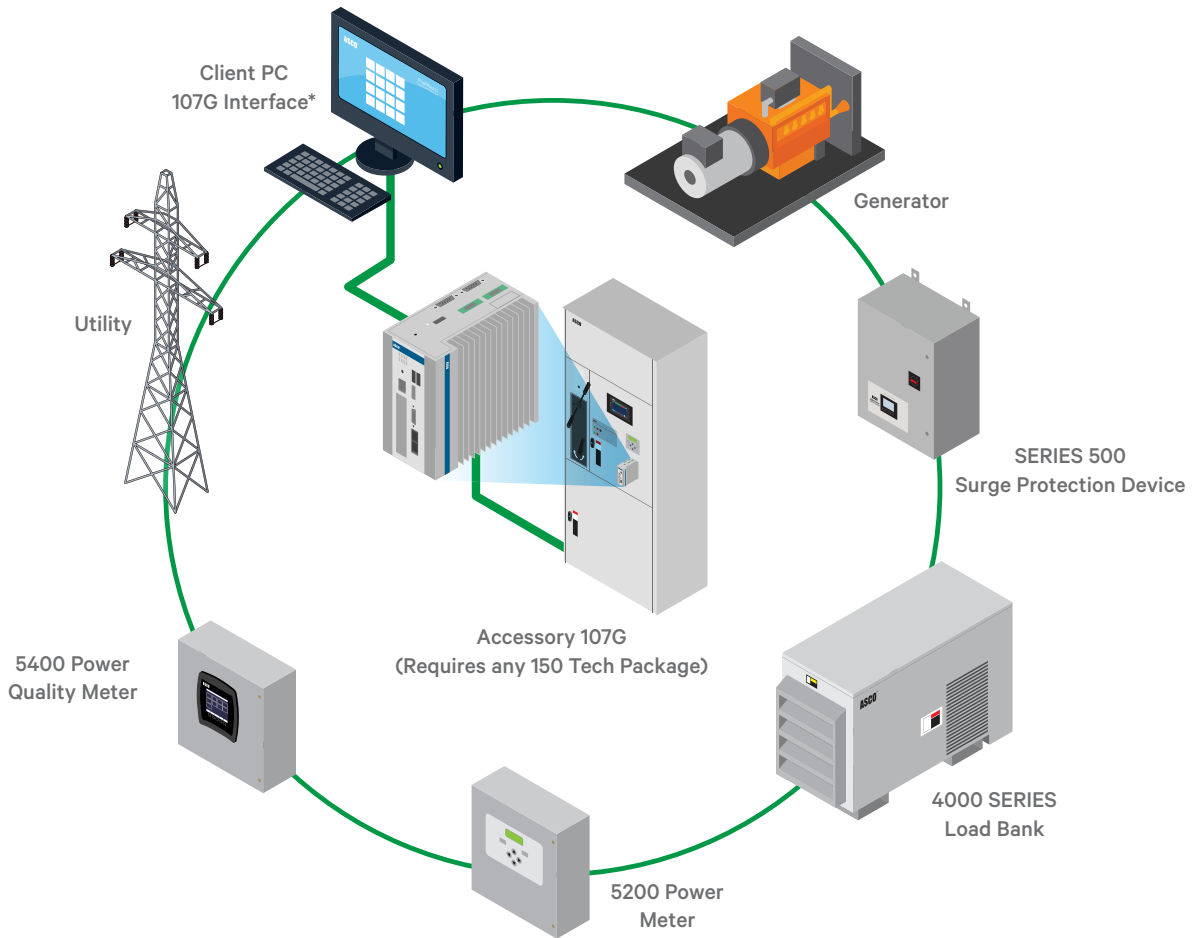

Meets NFPA and Joint Commission Compliance requirements

Provides required engine-generator and transfer switch safety indicators and shutdowns. Automatically generates NFPA test and utility outage reports. Listed to UL 1008.



Gain real-time status and performance insights

Provides instant access to critical utility power, engine-generator, transfer switch, surge protection and load bank information. Transmits immediate email and text alerts of alarm and event conditions.



Integrates with common building monitoring systems and the ASCO Critical Power Management System

Shares power system data with other monitoring systems, allowing greater analysis of operating data and faster response to changing conditions.

ASCO QUAD-ETHERNET MODULE ACCESSORIES

The Quad-Ethernet Module is the easiest way to connect, monitor and control your power transfer switch, utility power and engine-generator. Through the web app, you can monitor power conditions, start your engine-generator, and transfer between power sources.

Monitoring

- Engine-generator, utility, and transfer switch status
- Email Notification
- Alarms and Alerts
- Statistics and Activity
- Event Log (downloadable)
- Controller Setpoints
- Power Monitoring*
- Energy Consumption*
- Historical KW Demand*

*Accessory 150A or 150B

Control

- Engine Start/Stop
- ATS Transfer/Retransfer
- Generator Test
- Bypass Timer Delays

Communicate

- Modbus
- SNMP
- SMTP Advanced Encryption Standard
- Four Port Ethernet Switch
- RS485 Port



Quad-Ethernet Module
Accessory 72EE2

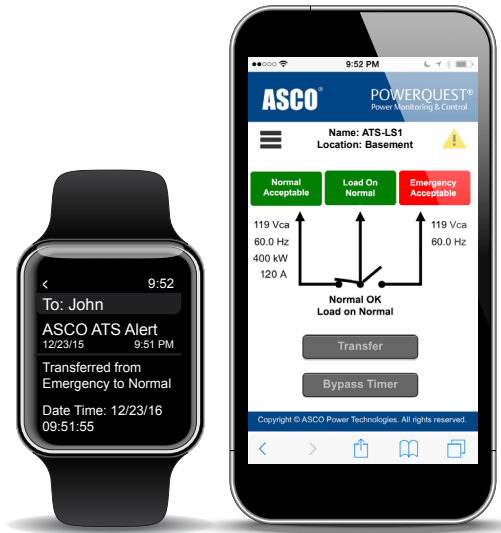

Ordering and Specifications Information

Ordering	
Catalog Number	5170
Catalog Name	Quad-Ethernet Module
Transfer Switch Accessory	72EE2
ATS Tech Package	150A for Non-Bypass
ATB Tech Package	150B for Bypass
Part Number for Kit	K1106217-001

Ports	
Ethernet	
Number of Ports	4
Type of Ports	RJ45, 10/100 BaseTX
Protocol	Modbus, SMTP, SNMP
RS485	
Number of Ports	1
Type of Connection	2-Wire or 4-Wire
Protocol	Modbus

ASCO ENERGY AND POWER METERS

5210 Power Meter

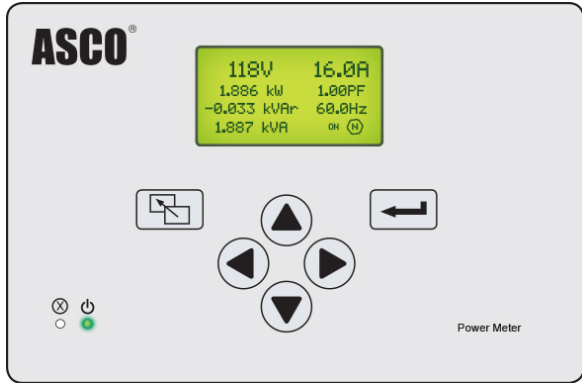

5400 SERIES Power Quality Meter



	Transfer Switch	Bypass Transfer Switch	Transfer Switch	Bypass Transfer Switch	Transfer Switch	Bypass Transfer Switch	Transfer Switch	Bypass Transfer Switch
Technology Packages	150A	150B	150A1	150B1	150A2	150B2	150A3	150B3
Meter Accessories	135L	135SB	140L	140B	140LS	140SB	140LX	140XB
Meter Catalog Number	5210		5410		5450		5490	
Energy and Power Measurements	Power factor (total), Apparent power (total), Active and reactive power (total), Active and reactive power (per phase, rms), Apparent power (per phase, rms), Power factor (per phase, rms), Voltage, Current, Frequency							
Power Quality Analysis	Total harmonics distortion		Continuous waveform recording, harmonics, inter-harmonics, voltage sag and swell detection, unbalanced components (zero, negative, positive), flicker, fast flickering, crest factor, K-factor					
Power Quality Analytics Software	No		Yes (Acc. 107G)		Yes (Acc. 107G)		Yes (Acc. 107G)	
Web-page interface	Yes		Yes		Yes		Yes	
Communications Protocol	Modbus TCP/IP, SNMP		Modbus TCP/IP		Modbus TCP/IP		Modbus TCP/IP	
BACnet IP Protocol	Yes (Acc. 107G)		Yes (Acc. 107G)		Yes (Acc. 107G)		Yes (Acc. 107G)	
Sampling Rate (samples per cycle)	32		256		512		1024	
Voltage Harmonics	15th		127th		255th		511th	
Internal Memory	128KB		128MB		4GB		16GB	
Transient Detection at 60/50Hz	No		65.1 / 78.1us		32.5 / 39 us		16.3 / 19.5 us	
NTP Time Synchronization	Yes (Acc. 107G)		Yes		Yes		Yes	
Digital Inputs / Outputs	-		-		8 / 4		16 / 8	
Analog Inputs / Outputs	-		-		4 / 4		8 / 8	
Form-C Relay Contacts	-		-		3		6	

ASCO ATS REMOTE ANNUNCIATORS

5350 8-ATS Annunciator



Cat. 5350



Cat. 5310

5705 8-Device Annunciator



Cat. 5705

Description	5350 8-ATS Annunciator	5705 8-Device Annunciator
Listed to UL 1008	Yes	Yes
NIST Compliant Security	AES 128-bit Encryption	AES 128-bit Encryption
Monitoring Interface	LED	Graphical Touchscreen
ATS Supported	Up to 8 (5310, 1-ATS)	Up to 8
Transfer and Engine-Start Control	Yes	Yes
Transfer Switch Monitoring	Transfer Switch Position, Source Availability, Time-Delay Active, Communications Status, Locked Out, Fail-to-Synchronize, Extended Parallel	
NFPA 110 Engine-Generator Safety Indicators and Shutdowns	No	Yes, any generator with ASCO 5212 PMU
Surge Protective Devices	No	ASCO SERIES 500 and 400 with Active Surge Monitoring
Load Bank	No	ASCO Avtron 5000 and 4000 SERIES with Accessory 150LB
Email Notification	No	Yes
Audible Alarm	Yes	Yes
Mounting	Wall or Flush-mounted	Wall-mounted
Common Alarm Output	Yes	Yes
Control Security	Key Lock	Multi-Level Password
Control Power	24VDC or 120VAC	24VDC or 120VA
Ethernet Ports	2	2
Power-outage ride-through (seconds)	0.1	60
ATS accessory required	Any ASCO Accessory 150 Technology Package or Accessory 72EE2	Any ASCO Accessory 150 Technology Package

ASCO 5700 CRITICAL POWER MANAGEMENT SYSTEM

Critical Facility, Power and Energy Management

The PowerQuest Critical Power Management System (CPMS) enables you to centrally manage your critical infrastructure and increase its reliability, efficiency, and regulatory compliance.



5700 SERIES Server with Touchscreen



System Overview

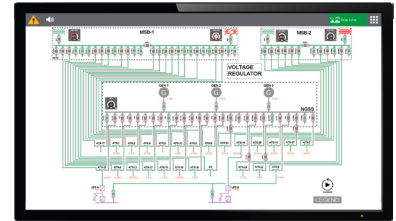

Dynamic One Line
(Engineering Services Option)

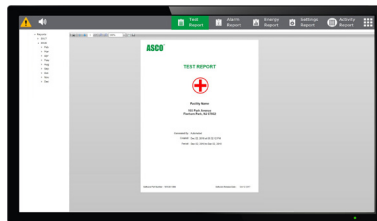

Automated Outage
and NFPA Compliance Reports



Alarm Dashboards

With the ASCO PowerQuest® CPMS, you can

- Understand power system and equipment status throughout a facility
- Quickly identify and resolve alarms to reduce downtime risk and increase reliability
- Monitor KW capacity and demand at any point in the distribution system
- Automatically generate outage reports for NFPA and Joint Commission compliance
- Ensure power quality compliance to increase the service life of business critical equipment and devices
- Leverage existing network infrastructure and add existing legacy equipment
- Analyze comprehensive forensic power quality and sequence of event data in millisecond granularity
- Identify utility energy usage and demand billing discrepancies
- Reduce or eliminate power factor and demand penalties
- Monitor, benchmark and increase energy efficiency
- Allocate energy costs to departments or processes

	5710	5750	5790
Hardware	Server+22-inch Touchscreen	Server+22-inch Touchscreen	Server+22 inch-Touchscreen
Number of Equipment Monitored	32	64	128 ¹
Remote Clients Support	3	10	25 ¹
Monitoring & Control	✓	✓	✓
Email Notification	✓	✓	✓
BMS Communications	✓	✓	✓
System Event Log		✓	✓
Historical Trending		✓	✓
Automated Reports		✓	✓
Power Quality Meter Analytics	✓	✓	✓
Reference Library		✓	✓
Redundant Storage			✓

¹ Consult ASCO for engineered dashboards, additional equipment or clients.

Life Is On

Schneider
Electric™

ASCO Power Technologies - Global Headquarters
160 Park Avenue
Florham Park, NJ 07932
Tel: 800 800 ASCO

www.ascopower.com
customercare@ascopower.com